



Limitorque® MX and QX Series B Smart Electric Actuators

Improved Reliability, Longer Service Life,
Lower Total Costs — Plus Faster and Easier to Use



Experience In Motion



The leading edge of smart actuation

Nothing exceeds Limitorque MXb multi-turn and QXb quarter-turn actuators from Flowserve for ease of use and compatibility with valves of all types. They're designed to accommodate a broad range of applications and process while providing:

- Repeatable precision
- Improved reliability
- Enhanced user experience
- Advanced diagnostics
- Lower total cost of ownership
- Enhanced safety
- Simplified maintenance
- Proactive maintenance with IoT insights

Best-in-class actuation for your demanding applications

The Limitorque portfolio of valve automation products from Flowserve has enabled companies around the world to address their most-challenging flow control issues.

The Limitorque brand has evolved since its strategic introduction of a torque-limiting design that changed the industry 80 years ago. Today, Limitorque smart actuators deliver:

- Significant total lifecycle cost savings
- Greater operating efficiencies and process optimization
- Increased visibility into equipment conditions to enhance performance and avoid unplanned downtime

Inside

The quick read	3
Applications for smart actuators	4
Next-generation smart actuation	6
Anatomy of actuators	8
Control and diagnostics	10
Flowserve FlowSync App for remote control	12
RedRaven complete IoT monitoring and analytics	14
BIST, absolute encoder and torque sensing	16
Standard features for indication and protection	18
Network communication protocols	20
Performance ratings	22
MXb LB linear drive actuators	24
QXMb multi-turn or QXMb LB linear actuators	25
Couplings	26
Technical details	27
Optional features	33
Certifications	34

The quick read

Electric actuators must perform reliably in severe environments and harsh conditions. Any failure can compromise valve performance, plant productivity and employee safety.

That's why Flowserve engineered the Limatorque MXb and QXb electric actuators for dependable performance across a broad range of tough applications, including:

- Oil and gas
- Petrochemical
- Commercial power
- Chemical
- Water
- Wastewater
- General industries

Ease of use

- Commissioning is 50% faster owing to a simplified menu and navigation, without the need for special tools.
- The high-resolution control panel display:
 - Delivers instant and up-to-the-minute actuator status and valve position
 - Shows clear historical and real-time graphs for critical process information such as torque, vibration and temperature profiles
 - Automatically adjusts brightness to enable visibility in all lighting conditions
 - Includes multiple languages for ease of use
 - Rotates to accommodate equipment orientations and installations

Reduced costs

- Backward compatibility enables cost-effective upgrading of existing MX and QX models to the advanced B series.
- Thermal resistance increases mean time between failure (MTBF).
- Oil bath lubrication extends the actuator life, enables storage and mounting in any orientation while maintaining full coverage, and eliminates the need for regular maintenance.

Design enhances reliability

- Improved reliability as the result of isolated inputs and outputs.
- Double-sealed enclosure up to IP68 (minimum 96 hours at 15 m), with separate terminal compartment eliminates the need for a heater and avoids the risk of water ingress during commissioning.
- Non-intrusive control knobs make it possible for the actuators to be sealed for life and eliminate risk of water/dust ingress.

Ensuring safe operation

- The independent handwheel disconnects the motor to enable manual reducing and provides a safety feature which can be engaged, even during motor operation.
- The LimiGard circuit monitor is designed for fail/no-action protection; it continually monitors the motor contactor, control relays, internal logic circuits and external command signal to detect and report malfunctions.



Applications for smart actuators

Compatible with broad range of valves

Limatorque MXb multi-turn and QXb quarter-turn actuators accommodate today's wide variety of valve designs and configurations and meet international standards for valve and actuator interfaces, including ISO 5210 and MSS SP-102.

MXb mounting options

MXb actuators are available in a wide variety of configurations to accommodate all rotary and linear valve applications:

- **Direct mounting:** Directly coupled with valves for torque-only applications. For thrust applications, MXb (and QXMb) actuators use a separate thrust base.
- **MXb with worm gearbox:** Coupled to a worm gear reducer (such as Limatorque WG or HBC models) for operation of part-turn valves, such as butterfly, ball, plug and damper. This combination provides an output torque capacity of up to 184,280 Nm (136,000 ft-lb).
- **MX with bevel or spur gearbox:** Rising stem valves coupled to a variety of bevel gear and spur gear reducers (such as Limatorque, V or SR models). Thrust up to 1,445 kN (325,000 lb) and torque up to 16,320 Nm (12,000 ft-lb) can be accommodated.

Learn about Limatorque gearboxes at <https://www.flowserve.com/gearboxes>.

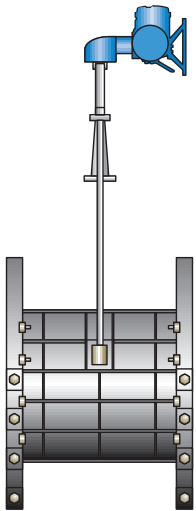

MXb and bevel gearbox mounted to sluice gate

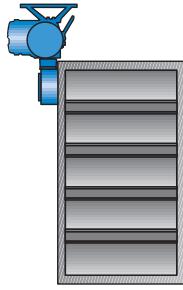

MXb and worm gearbox mounted to damper

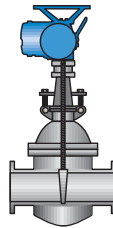

MXb directly mounted to wedge gate

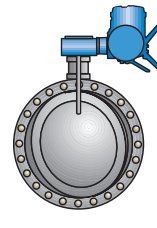

MXb and worm gearbox mounted to butterfly valve

QXb mounting options

QXb actuators can be directly coupled with all rotary valves for position-seated or torque-only applications.

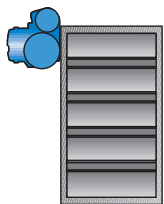

QXb directly mounted to damper

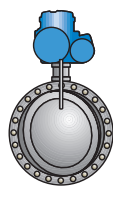

QXb directly mounted to butterfly valve



Compliance and certifications

MXb and QXb actuators are certified for compliance to international standards for ATEX, IECEx, FM and region-specific international certification organizations.

For more information about certifications, see pages 34 and 35 or contact your local sales representative.

The next generation in smart actuation

Realize unmatched reliability and precision with Limitorque MXb and QXb actuators from Flowserve. They also provide enhanced diagnostics and analytics plus a streamlined user experience to enable you to improve operations and safety while reducing costs.

First to provide repeatable precision

Tested dependability and condition monitoring

- Leverage the innovation of the first actuator developed with an absolute encoder that doesn't require troublesome and unpredictable battery back-up.
- Be confident that built-in self-test (BIST) enhancements and redundancy facilitate critical communication about equipment condition for comparison to the expected state. Any deviation is reported on the actuator screen or over a networked device.

Improved reliability

Protection from the outside environment

- Eliminate the need for a heater because the double-sealed IP68 enclosure — with a separate terminal compartment and non-intrusive control knobs — prevents dust and water ingress plus condensation, even without power.
- Ensure thermal resistance and extend equipment service life because the components are rated for a long mean time between failure (MTBF); in addition, a reinforced housing increases the actuator's operating ranges.
- Provide an IP68 enclosure regardless of whether the actuator is weather-proof or explosion-proof.
- Comply with NEMA 4, 4X and 6.

Enhanced user experience

Faster commissioning, setup and operation

- Enable up to 50% faster commissioning compared to previous models with a simplified multi-language menu and a rotary navigation knob.
- Cater to all knowledge and expertise levels by offering multiple configuration options with an intuitive menu.
- Configure in English, French, German and Italian plus Bahasa Indonesia, Katakana, Mandarin, Portuguese, Russian, Spanish and Turkish with the industry's first multi-lingual actuators.

Improved visibility from a safe distance

- Easily read a large, high-resolution LCD screen with adaptive brightness control from up to 9 m (30 ft).
- Rotate the control head up to 180° in 90° increments to ensure proper screen orientation, regardless of actuator mounting orientation.

Better visualization of data at the actuator

- Access data locally using the actuator's LCD interface or remotely via the FlowSync app or a laptop. (See pages 12 to 13 for details.)
- View real-time torque graphs, alarm and event logs, and other data in higher-quality resolution.
- Enhance visualization of operational graphs, logs and trend data with an advanced display that enables operators and technicians to quickly understand actuator conditions.

Advanced diagnostics and analytics

Increased memory improves captured data quality

- Investigate past events which are time-stamped and saved in memory 500+ times greater than previous models.
- Enable higher degrees of process monitoring, data logging and information feedback owing to the larger memory.
- Support asset management functions and lifecycle analysis with time-stamping.

Greater process visibility and control

- Easily integrate with other plant systems owing to a NAMUR NE107-compliant, diagnostic notification system.
- Enhance process performance monitoring by alerting operators to potential future failures with alarm and event conditions through an internationally accepted symbol standard.



Lower total cost of ownership

Easily retrofit display on existing actuators

- Update existing MXb and QXb actuators with conversion kits that retrofit the display and control assembly to provide all the advantages of new models.
- Reduce costs and future-proof your equipment investments with easy electronics interchangeability for backward compatibility with older models.

Enhanced safety

Manual positioning when needed

- Enable manual override with an independent handwheel that safely disconnects from the motor, even when it's running.
- Enhance safety and security by isolating the handwheel in manual or motor drive operation.
- *See additional safety certifications on pages 34 and 35.*

Simplified maintenance

Reduce maintenance time and costs

- Eliminate brackets, hold-downs and easily lost screws with the latch-and-eject connector design of the MXb and QXb actuators, which also ensures robust connectivity throughout the rated seismic and vibration envelope.
- Stop re-greasing while enabling mounting and storage in any orientation as a result of the oil bath lubrication.

Proactive maintenance with IoT insights

Monitor, analyze and predict actuator performance

- Compatible with RedRaven for Actuators, the complete end-to-end proactive maintenance solution for the industrial space from Flowserve.
- Works with other internet of things (IoT) systems that connect smart products, software and services.

Anatomy of MXb multi-turn and QXb quarter-turn actuators

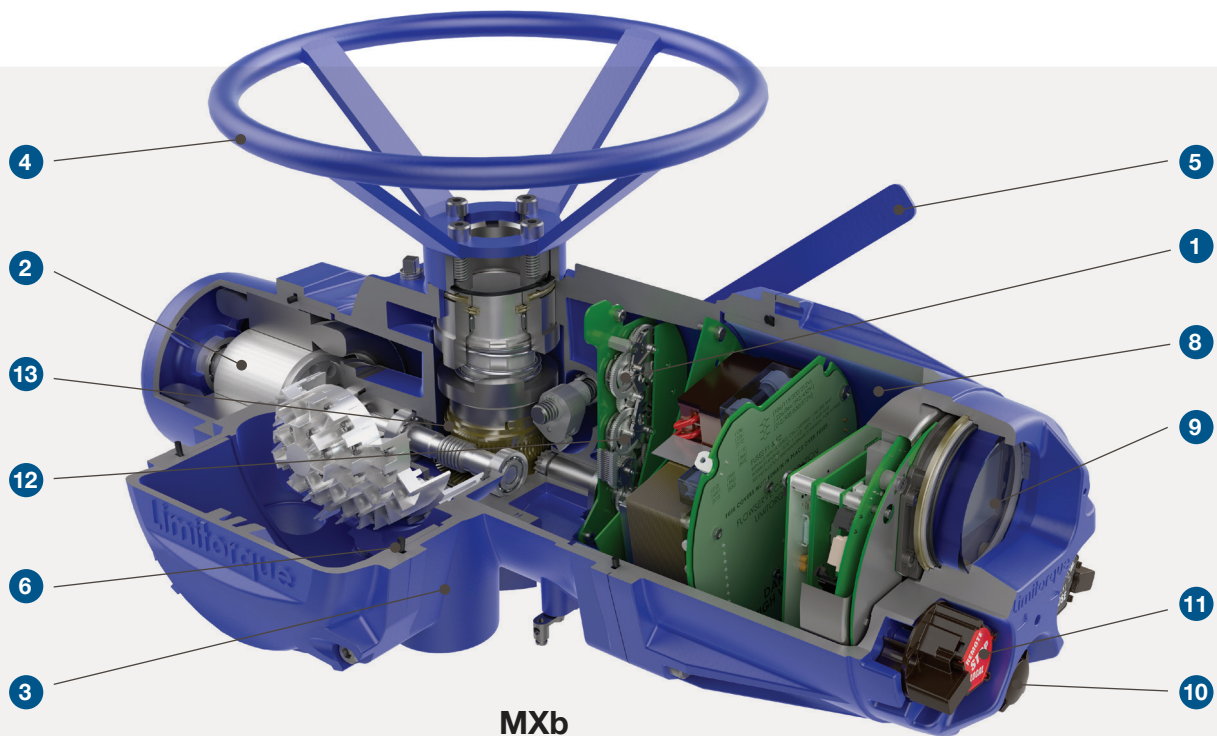

MXb

1. Absolute encoder

- The MXb actuator uses an 18-bit resolution encoder, which allows for more than 10,000 drive sleeve rotations, and is 100% repeatable.
- The QXb actuator employs system-on-chip technology in its encoder and a non-contacting magnet to excite Hall effect devices, providing redundant, 12-bit resolution over 360°.
- Both units feature a built-in self-test (BIST) that enables each actuator to function reliably with built-in redundancy and without the need for an internal battery.

2. Motors

Three-phase AC (MXb)

- Reduces valve position overshoot owing to design optimized to handle high starting torque and low inertia.
- Includes Class F insulation; Class H is optional.
- The motor gear attachment enables the motor to be removed in one assembly for fast, easy inspection, repair and maintenance.

Brushless DC (QXb)

- Eliminates sparks, reduces mechanical and electrical noise, and dissipates heat better than brushed motors.
- Lasts longer than conventional motors and enables more accurate positioning while permitting a global range of voltages (single-phase and three-phase AC and DC) to be used.

3. Cast aluminum housing

- Cast 356-T6 grade aluminum with powder coating resists corrosion in extreme environments.
- Optional coatings available.

4. Handwheel

- The independent handwheel meets most minimum rim pull requirements and is available for emergency control when power is lost.

5. Declutch lever

- Enables manual operation with a handwheel.
- The lever automatically disengages — even when the motor is running — and can be padlocked for safety and security.
- The lever can be moved to manually isolate the handwheel during a power outage or emergency.

6. Double-sealed enclosure

- Complies with IP68 (refer to global certifications on pages 34 to 35)
- Separate, water-tight terminal compartment eliminates the need for a heater and avoids the risk of water ingress during commissioning.
- Control components are never exposed to the elements during site wiring or because of loose or faulty conduit cable connections.

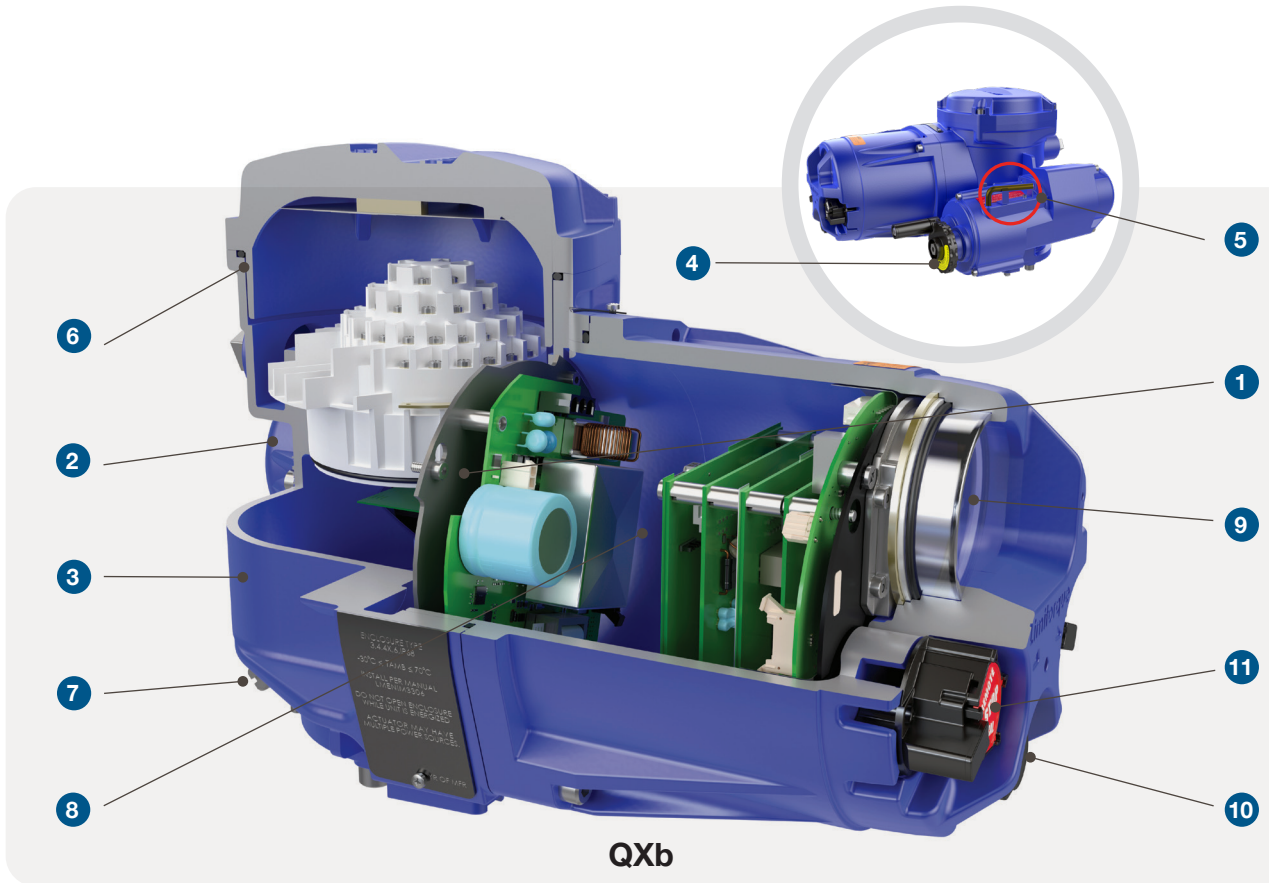

QXb

7. Mechanical stop bolts (QXb only; not shown)

- Mechanical stop bolts are supplied for 90° movements.

8. Control chamber

- The MXb and QXb actuators utilize the same electronics package, but the QXb has an additional feature: a solid state motor controller.
- This design permits a wider range of customer-supplied voltages (single- or three-phase AC or DC) to be connected with simple modifications to the QXb actuator electronics.
- The location of the handwheel enables easy commissioning.

9. LCD multi-lingual display

- The MXb was the first non-intrusive, multi-turn actuator to equip users with LCD dialogue screens in the language of their choice.
- The control panel delivers instant, up-to-the-minute actuator status and valve position in multiple languages.
- It also simplifies set-up and commissioning and diagnostic information, including motor, identification and hardware data, as well as torque profile and log reports.

10. Rotary knobs

- Enable users to easily navigate menu options and make faster yet precise selections, particularly during set-up and configuration.
- Provide access to analytic and diagnostic information, including live graphs and logs via the Quick Access menu while the actuator is moving.

11. Local control switches

- Local control switches make set-up and commissioning simple, enabling easier selection of options and movement through the simplified menus.
- Provide the abilities to open, stop and close the actuator and select remote or local preferences.
- These switches are magnetically coupled, solid-state Hall effect devices, which eliminate troublesome and fragile reed switches.

12. Torque sensing

- The MXb actuator determines torque from motor speed, voltage and temperature.
- The QXb actuator determines torque from motor current, with compensation performed for voltage and temperature variations.
- Torque sensing for both models is highly reliable and predictable without the need for the extra components associated with electromechanical torque switches.

13. Worm and motor gear set (not shown on QXb)

- The internal gears are designed for performance and longevity.
- Rolled/ground gears are bearing supported and immersed in an extended-life, synthetic gear oil specifically designed to improve efficiency and minimize wear.

Superior control and diagnostics

Smart but simplified configurations enable critical control

Control is expected in a smart actuator. Limitorque MXb multi-turn and QXb quarter-turn actuators from Flowserve help you do so much more by simplifying valve automation in three critical methods of control:

- Set-up and commissioning
- Normal operation
- Diagnostics and troubleshooting

Easier menu navigation and selection of options confirm the setup of the MXb and QXb actuators via solid-state Hall effect devices in both knobs. No special tools or remote devices are required. And the Flowserve FlowSync app provides operators and technicians with access to configure actuation equipment and retrieve performance data via a secure Bluetooth connection.

In addition, MXb and QXb actuators are “fit for service”, offering the widest range of configuration menus of any non-intrusive smart actuator.



Advanced setup



Main menu



Quick setup

Advanced diagnostics enable proactive maintenance

MXb and QXb actuators incorporate advanced diagnostics that provide greater process visibility and control. They feature an enhanced, NAMUR NE107-compliant diagnostic system that provides higher process control by alerting operators when alarm and event conditions occur.

The diagnostics system tracks the actuator environment and performance through a sophisticated set of sensors. Any deviation of voltage, operation, torque and vibration from specified ranges is reported. That enables operators to adjust configurations and schedule proactive maintenance, when necessary, before equipment failures occur.



Data logging and alarms

In addition, MXb and QXb actuators include a time-stamped data log of local and remote move commands as well as events and alarms.

The event and alarm list is configurable and stores thousands of historical actions. The data logging system is backed up by an internal battery with an operating life of more than 10 years.





The smarter way to safely control your actuator equipment



Getting close to actuator equipment in industrial settings is easier said than done.

With the Flowserve FlowSync app, you can control your actuator equipment and save time by configuring and commissioning one actuator or multiple units faster in the workshop or at the installation site.

The Flowserve FlowSync app can digitize your critical processes, while making them more efficient and accurate with advanced monitoring and diagnostics

Quickly configure and monitor actuator condition

Using familiar touch-screen commands, securely connect to smart actuators via Bluetooth to configure them or change settings remotely.

The Flowserve FlowSync dashboard helps immediately identify conditions or issues by viewing actuator status, valve/actuator position, torque, RPMs along with temperature measurements.

- **Learn an actuator's overall health**, confirm its position, and check its voltage and torque.
- **Save time** by configuring and commissioning one actuator or multiple units quickly on- or off-site.
- **Quickly see** which units are ready to go. And if there's a commissioning issue, a Flowserve expert is a click away.

It's exactly the support you need to accomplish priority operational objectives and strategic energy transition initiatives.

Tested, proven security

Your equipment and data will remain secure because we've tested how FlowSync communicates across networks and stores your critical configuration and performance information.

Get the free app



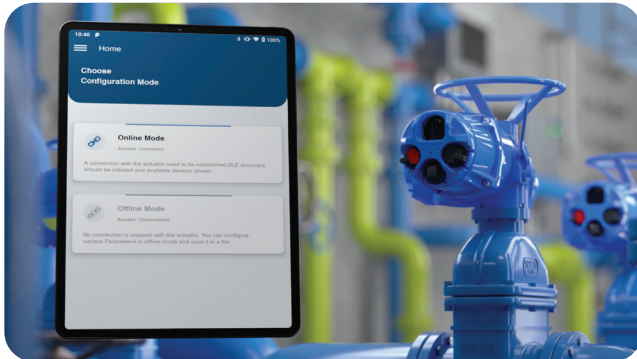

Securely connect to smart actuators via Bluetooth to configure them or change settings remotely.

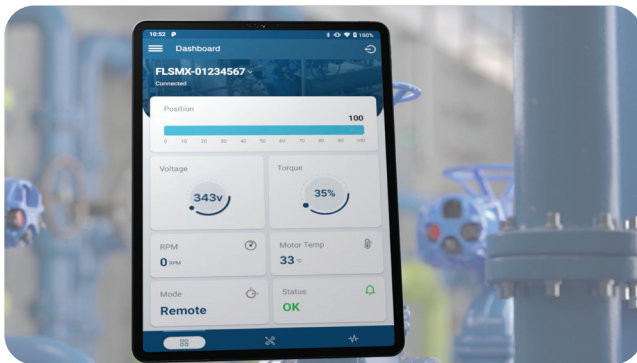

Immediately identify conditions or issues by viewing actuator status and RPMs along with temperature measurements. Confirm the actuator's position and check its voltage and torque.



Get easy access to diagnostic data such as torque, vibration and temperature profiles.

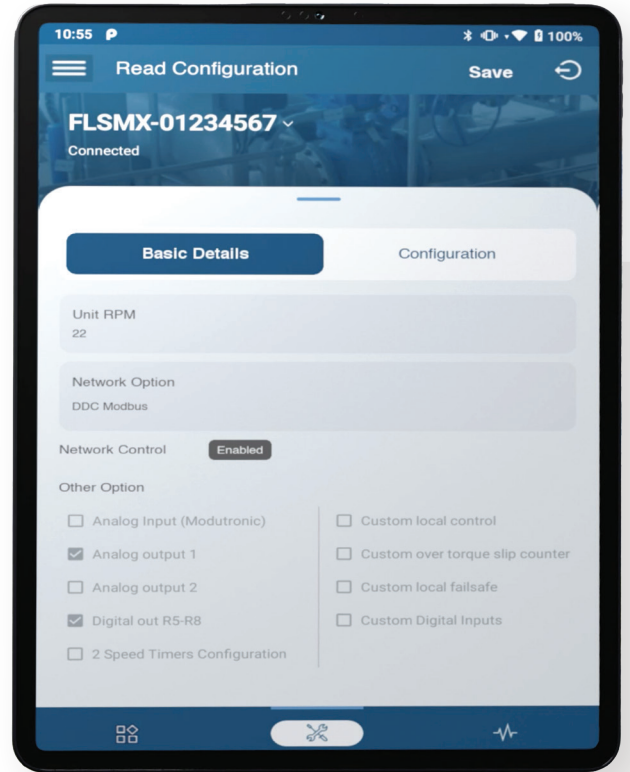

Save time by configuring and commissioning one actuator or multiple units faster in the workshop or at the installation site. Quickly see which units are ready to go.



Avoid unplanned downtime with IoT monitoring and analytics

IoT and RedRaven compatible

MXb and QXb actuators are IoT compatible with a range of networking, monitoring, and control equipment and systems.

They're also RedRaven Ready, which means they're designed to work with the suite of IoT solutions from Flowserve that can be scaled to meet your unique process and facility requirements, including:

- Hazardous area-certified equipment sensors
- Secure communications
- Performance analytics
- Trend reporting tools

With access to advanced analytics and trend data, you can identify the slightest changes in flow control equipment performance — variations that can indicate a problem is looming.

You'll also get real insights needed to make more informed decisions to improve your plant's efficiency, productivity and bottom line.

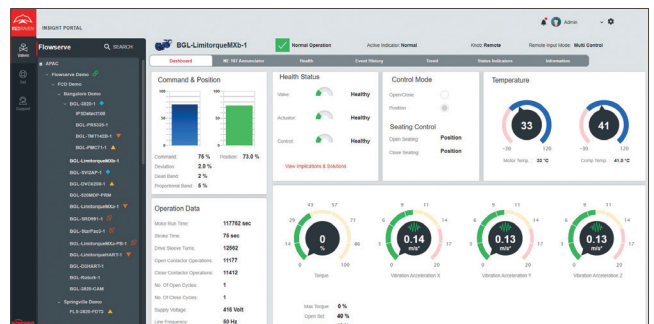

RedRaven for Actuators helps to lower costs and improve safety

Get the insights and tools you need to monitor, analyze and predict the performance of MXb and QXb actuators plus valves, pumps and seals — the collective lifeblood of your plant. With RedRaven for Actuators from Flowserve, you can quickly respond to minimize disruptions and downtime.

RedRaven is a complete end-to-end proactive maintenance solution for the industrial space. It enables you to leverage the internet of things (IoT) for connected smart products, software and services.

Proactively identify and address actuation issues

RedRaven advanced IoT condition monitoring helps plants monitor the condition and performance of actuators and other fluid motion and control equipment in process industries. Informed by the predictive analytics capabilities of RedRaven, plant operators and technicians can schedule maintenance and repairs to proactively address equipment issues before they become failures.

Smart electric actuators have built-in diagnostics, but RedRaven extends its IoT condition monitoring solution to the MXb and QXb actuators. By providing an overview of equipment health and offering corrective steps to take, plant operators can avoid unplanned downtime, improve performance, and increase reliability.

With real-time performance data and predictive analytics, you can act promptly to meet production timelines, minimize costs, and achieve business objectives. With RedRaven from Flowserve, you can keep actuation problems from evolving into production-stopping failures.

Support energy transition and sustainability initiatives

RedRaven condition monitoring and predictive analytics also enable plants to enhance safety and improve sustainability in operations. It detects changes that enable operators and technicians to schedule maintenance and repairs in order to minimize or eliminate leakage and fugitive emissions and maximize efficiency.

IoT solutions for your entire plant

The RedRaven platform comprises a suite of scalable technologies and service offerings that can be customized to meet your plant's unique needs.



Performance integrity and predictability

Accurately sense and confirm torque and actuator positions

Smart actuators should have enabling technologies that ensure performance integrity and predictability. The MXb and QXb actuators offer three:

1. Limitorque LimiGard™ – with built-in, self-testing (BIST)

You can enhance flow control equipment reliability, optimize plant operations, and reduce troubleshooting costs by utilizing our unique smart actuator monitor, Limitorque LimiGard.

Its numerous BIST features contribute to the integrity and predictability of process applications and enhance the ability of a safety system to achieve the highest possible rating.

- Limitorque LimiGard **continually monitors the control relays, internal logic circuits and external command signals**, comparing them to reference conditions.
- This virtually eliminates the possibility that an actuator malfunction can occur without **prompt detection and alarm communication**.
- In the event of a malfunction, LimiGard takes over and supervises the actuator's response characteristics, **maximizing safety and predictability**.

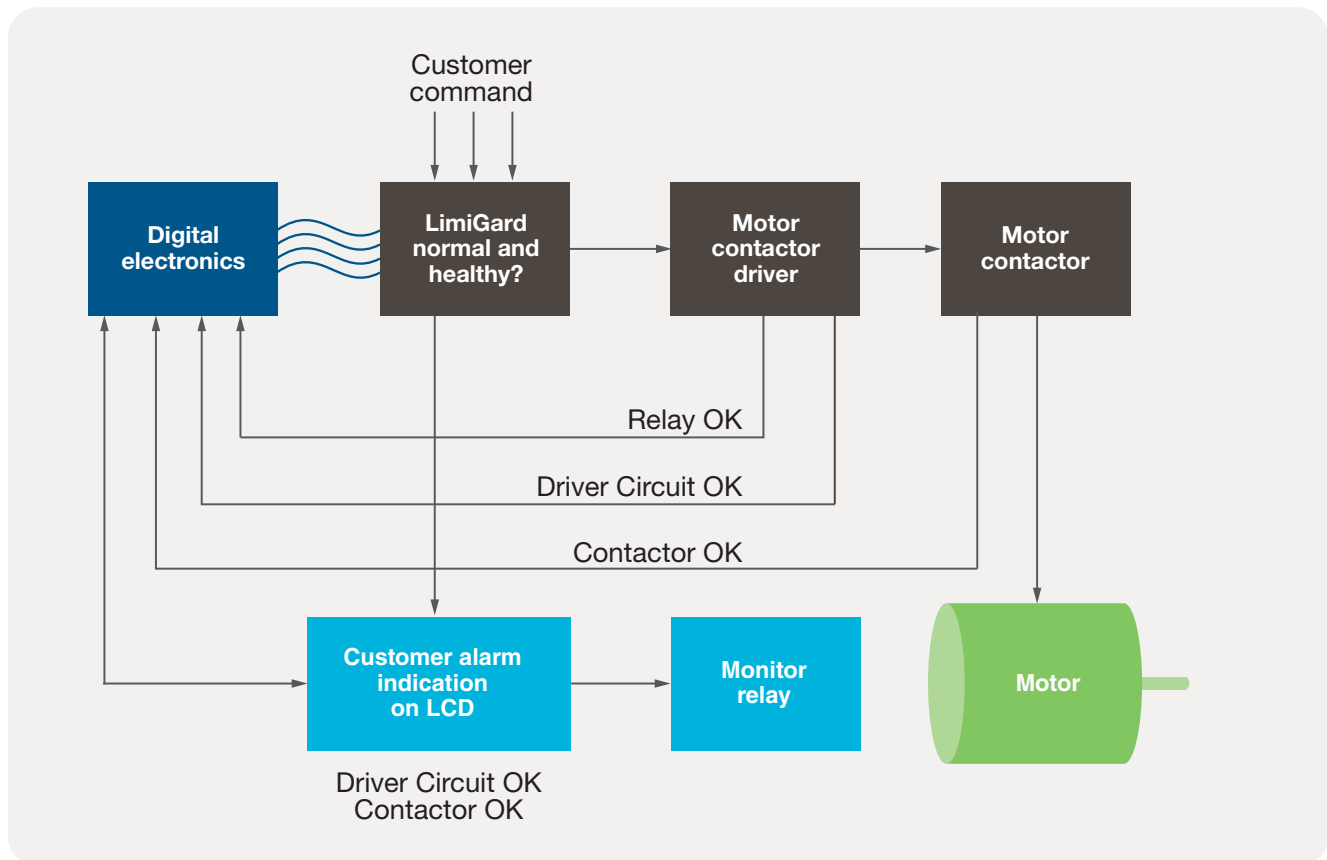

2. Absolute position encoder

Flowsolve developed the MXb and QXb actuators as the first electric actuators to use absolute encoders that don't require battery back-up. The encoders measure valve position at all times, including both motor and handwheel operations, with or without power present.

How the MXb actuator determines valve position

- Uninterrupted performance is proved with an improved, 18-bit optical, 100% repeatable device.
- The 18 bits also means that the encoder span is now almost 10x the original — good for ~10,000 drive sleeve rotations.
- The encoder has redundant circuits, ensuring performance, even in the event of up to 50% component failure, continuing to provide reliable data while alerting the user to any faults.

How the QXb actuator determines valve position

- System-on-chip technology using a contactless magnet excites Hall effect devices to provide redundant, 12-bit resolution over 360°.
- This redundancy, part of the BIST features, means the device can continue to function reliably in the event of a failure to one of the position sensors.
- As the actuator turns, a mechanical coupling rotates the magnet about an array of several Hall effect devices. When the magnet passes over a Hall effect device, it changes the electromagnetic field, and a digital signature (on-off) is developed.
- This signature is duplicated across the array of Hall effect devices at specifically timed intervals, resulting in digital values that calculate the position of the valve with 0.01% accuracy.

3. Torque sensing

- MXb and QXb actuators were the first electric actuators to sense torque electronically for use in valve control, overload protection and torque trending. The result is highly reliable and predictable torque sensing **without the need for the extra components** associated with electromechanical torque switches.

How the MXb actuator senses torque

- A microprocessor calculates output torque from motor speed, voltage and temperature.
- Torque limit may be set from 40 to 100% of rating in 1% increments.
- A “Jammed Valve Protection” feature can de-energize the motor if the output torque requirement exceeds the boost torque.
- A boost function is included to prevent torque trip during initial valve unseating and extreme arctic temperature operation.

How the QXb actuator senses torque

- The QX senses torque electronically for use in valve control, overload protection and torque trending.
- Torque is sensed from motor current, with compensation performed for voltage and temperature variations. The result is highly reliable and predictable, without the need for the extra components associated with electromechanical torque switches.

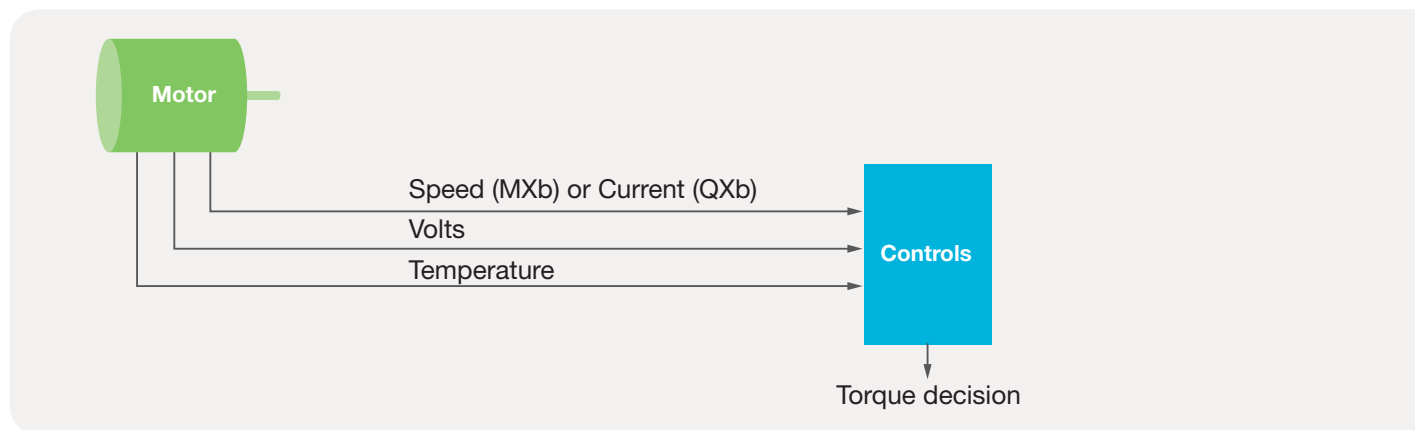



MXb

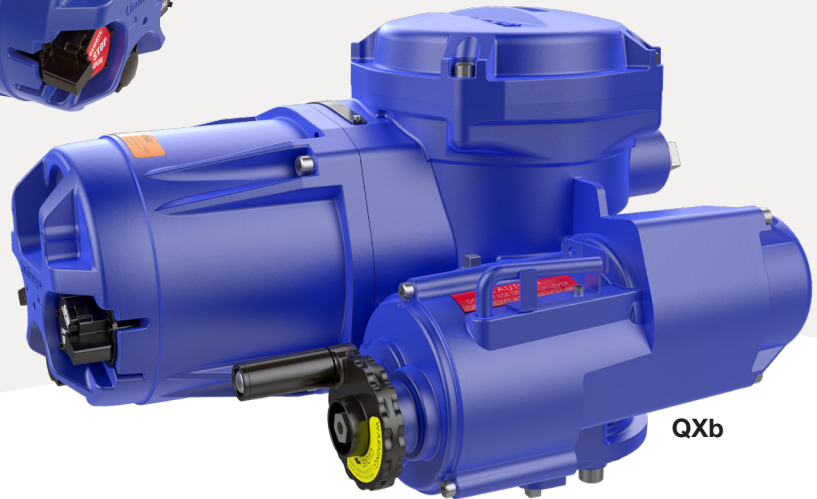

QXb

Standard features for indication and protection

Direct-wired remote control

Wiring flexibility includes the following standard alternatives to open-stop-close the actuator:

- **Four-wire** — Valve can be opened, closed or stopped.
- **Two-wire switched** — Single open or closed contact; valve can be opened or closed but not stopped.
- **Three-wire maintained** — Two momentary contacts for self-maintained control. Valve can be opened or closed but not stopped in mid-travel.
- **Three-wire inching** — Two “push-to-run” contacts; valve can be opened, closed and stopped in mid-travel.

Multi-mode control

Three modes of remote control are permitted when the actuators are configured for multi-control — digital (discrete) control, analog (Modutronic) control, or network (Fieldbus) control — and do not require local setting changes.

The MXb and QXb actuators respond to the last command received. However, analog control is initiated by either toggling

User Input 2 (configured for CSE input) or removing and reapplying the 4-20 mA analog signal.

Configurable inputs

Three configurable inputs are available when using a standard wiring set-up.

- **Emergency shutdown (ESD)** — Up to three remote, external ESD signals may be applied to the actuator to move the valve to a predetermined, user-configured shutdown position, overriding existing control signals.
- **User inputs** — Three user-defined inputs facilitate network connections.
- **Inhibit signals** — External signals may be used to inhibit actuator opening, closing or both.

Control signals

The control signal can be either 24 VDC or optional 110 VAC; it can be sourced from the actuator or customer supply.

Output relays

- **Status contacts** — May be set to represent more than 30 actuator conditions.
- **Monitor relay** — Provides an N/O and N/C contact representing “Actuator available for remote operation.”

Alternate speeds

MXb and QXb actuators can be configured to permit differing speeds for Open or Close direction. (Standard on QXb units; optional on MXb units.)

Uninterrupted power supply (UPS)

UPS is a standard feature with a 24-volt DC connection for either early commissioning prior to main power or actuator status and feedback in the event main power is lost.

Bluetooth LE capable

Standard low-power wireless communication path to the actuator enables monitoring and configuration of the unit wirelessly in any direction via the FlowSync app or a Bluetooth LE-compatible laptop.

- 128-bit data encryption can be enabled to protect the privacy of the link with the additional option to turn off Bluetooth at the actuator.
- A visible blue LED in the LCD display of the actuator signifies an active Bluetooth link to the actuator has been established.
- Bluetooth can be deactivated if required.

Protection features

Autophase protection and correction ensure proper open/close directions and monitors and corrects phasing if connected improperly. This prevents operation of the actuators if a phase is lost.

Other protection features include:

- **Jammed valve** — Detects lack of movement of the valve after movement command of actuator.
- **Instantaneous reversal protection** — Incorporates a time delay between motor reversals to reduce current surges.
- **Motor thermal protection** — A thermistor placed within the motor provides diagnostics feedback of the motor temperature and protects against overheating.
- **LimiGard circuit protection** — Refer to page 16 for more information.



Network communication protocols

MXb and QXb actuators are compatible with a comprehensive portfolio of network protocols and solutions such as:

- Modbus
- Profibus DP
- Profibus PA
- TCP/IP
- Foundation Fieldbus H1
- HART
- DeviceNet

Network ethernet interconnectivity also is available. Contact your Flowserve representative for details.



Advanced diagnostic capabilities

The full suite of diagnostics data can now be accessed from MXb and QXb actuators through a new or existing Modbus or Profibus DP network, without having to change any of the existing wiring or set-up, or alter the Ethernet.

These advanced digital communications for systems operations and diagnostics enable plant operators to have full access to the actuator data remotely, avoiding the need to manually download the data at the actuator to operate flow control systems with efficiency and long-term reliability. Limatorque MX/QXb actuators include built-in-self-test (BIST) and diagnostic software that record and analyze critical operating parameters such as:

- Temperature
- Span of travel vs. time
- Torque
- Valve travel
- Valve cycle counts
- Vibration

Embedded diagnostic features include partial stroke and emergency shutdown tests to enable operators and technicians to better understand equipment conditions to proactively schedule maintenance or repairs.

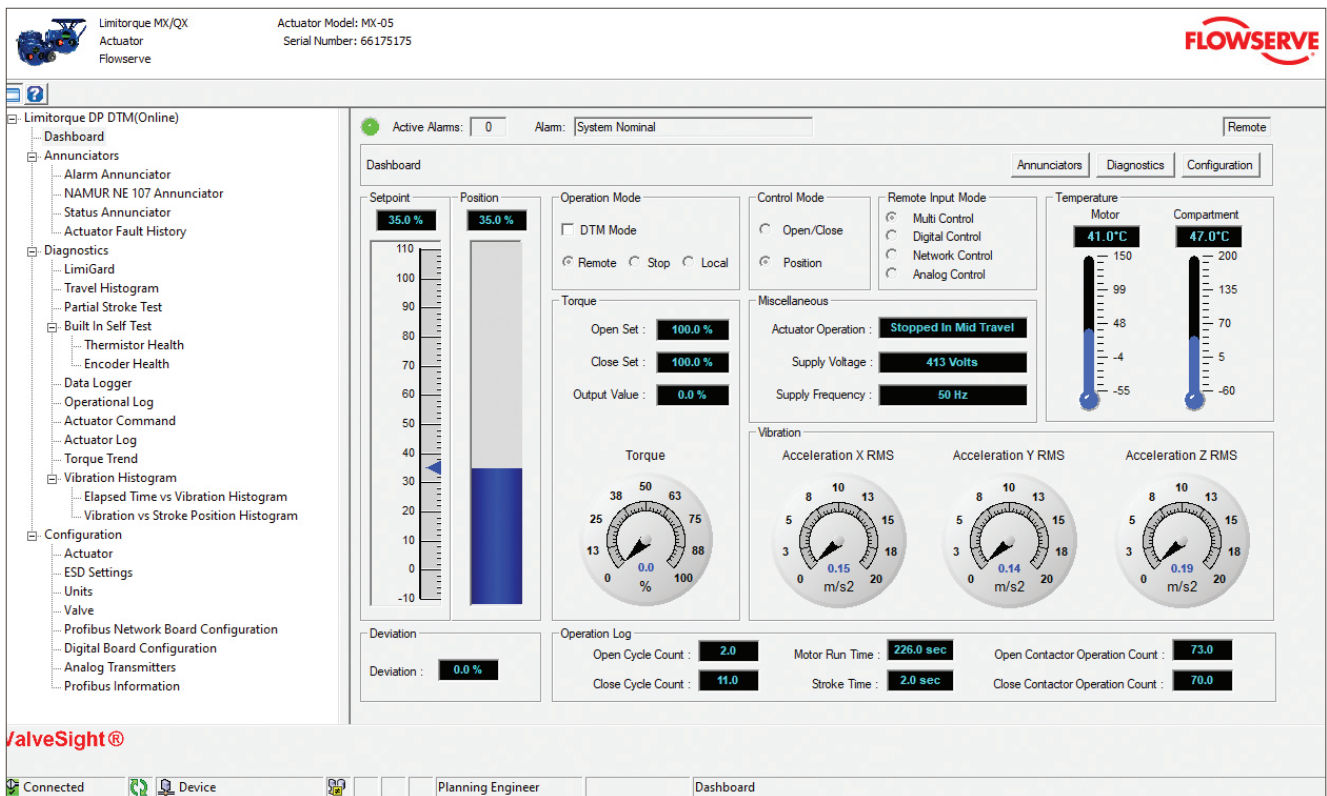

A Profibus DTM dashboard displays operational data and condition insights available with MXb and QXb smart actuators.



Control with Limatorque Master Station IV

MXb and QXb actuators equipped with a Modbus option card can be controlled via the Limatorque Master Station IV. It includes:

- Network control (up to 250 devices)
- Host interface — Industry-standard Modbus RTU, ASCII, and TCP/IP protocols and control
- TFT touch-screen display for network configuration status
- Configurable polling sequence priority
- Network time protocol for time synchronization of alarms diagnostics data to host device
- Email notifications of alarm conditions
- Downloadable data and event logging
- Independent or two units coupled together for redundant communications (hot-standby)



MXb series performance ratings

Rated output torque by speed and model

Output speed, rpm		Rated output torque, Nm (ft-lb)						
60 Hz	50 Hz	MXb-05	MXb-10	MXb-20	MXb-40	MXb-85	MXb-140	MXb-150
18	15	75 (55)	170 (125)	N/A	N/A	N/A	N/A	N/A
26	22	75 (55)	170 (125)	305 (225)	597 (440)	1,153 (850)	2,036 (1,500)	N/A
40	33	75 (55)	170 (125)	305 (225)	597 (440)	1,662 (1,225)	2,307 (1,700)	N/A
52	43	75 (55)	170 (125)	305 (225)	597 (440)	1,561 (1,150)	2,171 (1,600)	N/A
77	65	65 (48)	145 (107)	241 (178)	468 (345)	1,153 (850)	1,628 (1,200)	N/A
100, 131 ⁽¹⁾	84, 110 ⁽¹⁾	53 (39)	121 (89)	201 (148)	388 (286)	814 (600)	1,106 (815)	2,036 (1,500)
155, 170 ⁽¹⁾	127, 143 ⁽¹⁾	56 (41)	121 (89)	190 (140)	353 (260)	611 (450)	882 (650)	1,561 (1,150)
200	165	46 (34)	99 (73)	155 (114)	285 (210)	N/A	N/A	N/A

(1) MXb-85, MXb-140 and MXb-150

Mounting bases and thrust ratings by model

Parameter	MXb-05	MXb-10	MXb-20	MXb-40	MXb-85	MXb-140	MXb-150
Mounting base (MSS SP-102/ISO 5210)	FA/F10	FA/F10	FA/F14	FA/F14	FA/F16 FA/F25 (optional)	FA/F25	FA/F25
Thrust, kN (lb)	35 (8,000)	66 (15,000)	111 (25,000)	160 (36,000)	222 (50,000)	333 (75,000)	333 (75,000)

Handwheel data by model

Parameter		MXb-05	MXb-10	MXb-20	MXb-40	MXb-85	MXb-140	MXb-150
Handwheel type, ratio	Standard	Top-mounted, 1:1	Top-mounted, 1:1	Top-mounted, 1:1	Top-mounted, 1:1	Side-mounted, 16:1	Side-mounted, 16:1	Side-mounted, 16:1
	Optional	N/A	Side-mounted, 8:1	Side-mounted, 12:1	Side-mounted, 24:1	Side-mounted, 48:1	Side-mounted, 48:1	Side-mounted, 48:1
Side-mounted handwheel efficiencies	Standard	N/A	N/A	N/A	N/A	53%	53%	53%
	Optional	N/A	56%	60%	55%	51%	51%	51%

Stem diameter capacity by coupling and model

Coupling type		Maximum stem diameter, mm (in.)						
		MXb-05	MXb-10	MXb-20	MXb-40	MXb-85	MXb-140	MXb-150
Type A	A1/A1E (extended nut)	32 (1.26)	40 (1.57)	60 (2.36)	67 (2.64)	88 (3.50)	88 (3.50)	88 (3.50)
"Type B (torque only) ⁽²⁾	B4	25.4 (1)	30 (1.25)	50 (1.94)	55 (2.2)	70 (2.75)	65 (2.625)	65 (2.625)
	B4E (extended nut)	19 (0.75)	22 (0.91)	41 (1.56)	46 (1.78)	57 (2.25)	57 (2.25)	65 (2.625)
	B1 (fixed bore)	42 (N/A)	42 (N/A)	60 (N/A)	60 (N/A)	N/A (N/A)	N/A (N/A)	N/A (N/A)
	"BL (splined)	6 and 38 splines	6 and 38 splines	6 and 36 splines	6 splines	N/A	N/A	N/A

(2) Maximum bores for Type B may require rectangular keys.

Bore and keyway dimensions by coupling type

Dimension	MXb-05	MXb-10	MXb-20	MXb-40	MXb-85	MXb-140	MXb-150
B4 maximum bore and key, mm (in.)	Ø25.4, 8 X 7 (Ø1, 1/4 sq)	Ø30, 10 X 8 (Ø1.25, 1/4 sq)	Ø50, 14 X 9 (Ø1.94, 1/2 X 3/8)	Ø55, 16 X 10 (Ø2.2, 1/2 X 3/8)	Ø70, 20 X 12 (Ø2.75, 5/8 X 7/16)	Ø65, 18 X 11 (Ø2.625, 5/8 X 7/16)	Ø65, 18 X 11 (Ø2.625, 5/8 X 7/16)
B4E maximum bore and key, mm (in.)	Ø18, 6 X 6 (Ø0.75, 3/16 sq)	Ø22, 8 X 7 (Ø0.91, 1/4 sq)	Ø41, 12 X 8 (Ø1.56, 3/8 sq)	Ø46, 14 X 9 (Ø1.78, 1/2 X 3/8)	Ø56, 16 X 10 (Ø2.25, 1/2 X 3/8)	Ø56, 16 X 10 (Ø2.25, 1/2 X 3/8)	Ø56, 16 X 10 (Ø2.25, 1/2 X 3/8)

Weights by base

Base type	Weight, kg (lb)						
	MXb-05	MXb-10	MXb-20	MXb-40	MXb-85	MXb-140	MXb-150
MXb + B4 base (torque only)	24 (52)	29 (65)	49 (109)	60 (133)	114 (250)	136 (300)	182 (431)
MXb + A1 base (thrust only)	28 (61)	33 (74)	63 (138)	73 (162)	146 (322) ⁽³⁾	186 (411) ⁽⁴⁾	232 (542) ⁽⁴⁾
MXb + LB1 linear base	35 (76)	40 (89)	N/A	N/A	N/A	N/A	N/A
MXb + LB2 linear base	N/A	N/A	78.5 (174)	89.5 (198)	N/A	N/A	N/A

(3) MXb-85 with FA/F16 base (4) MXb-140 or MXb-150 with FA/F25 base

QXb series performance ratings

Mounting bases, operating times and torques by model

Parameter	QXb-1	QXb-2	QXb-3	QXb-4	QXb-5
Rated seating torque, Nm (ft-lb)	136 (100)	339 (250)	542 (400)	1,017 (750)	2,033 (1,500)
MSS SP-101 Base FA/ISO 5211	FA/F05, 07, 10	FA/F07, 10	FA/F12, 14	FA/F12, 14	FA/F12, 14
Minimum operating time over -10°C (14°F), s	5	8	15	30	60
Maximum operating time, s	20	30	60	120	120
Minimum operating time under -10°C (14°F), s	10	10	30	60	60
Maximum seating torque by limited base, Nm (ft-lb)	No derate	FA/F07 base: 270 (200)	No derate	No derate	FA/F12 base: 1,350 (1,000)

Bore and keyway dimensions by model and base

Dimension	QXb-1	QXb-2	QXb-3	QXb-4	QXb-5
Maximum diameter bore and square key, in.	FA/F05: Ø0.875, 3/16 sq FA/F07: Ø1.1875, 1/4 sq FA/F10: Ø1.625, 3/8 sq	FA/F07: Ø1.1875, 1/4 sq FA/F10: Ø1.625, 3/8 sq	FA/F12: Ø2.375, 5/8 sq FA/F14: Ø2.375, 5/8 sq	FA/F12: Ø2.375, 5/8 sq FA/F14: Ø2.375, 5/8 sq	FA/F12: Ø2.375, 5/8 sq FA/F14: Ø2.375, 5/8 sq
Maximum diameter bore and rectangular key, in.	FA/F05: Ø0.875, 1/4 X 3/16 FA/F07: Ø1.25, 1/4 X 3/16 FA/F10: Ø1.75, 3/8 X 1/4	FA/F07: Ø1.25, 1/4 X 3/16 FA/F10: Ø1.75, 3/8 X 1/4	FA/F12: Ø2.50, 5/8 X 7/16 FA/F14: Ø2.50, 5/8 X 7/16	FA/F12: Ø2.50, 5/8 X 7/16 FA/F14: Ø2.50, 5/8 X 7/16	FA/F12: Ø2.50, 5/8 X 7/16 FA/F14: Ø2.50, 5/8 X 7/16
Maximum diameter bore and key, mm	FA/F05: Ø22, 6 sq FA/F07: Ø30, 8 X 7 FA/F10: Ø42, 12 X 8	FA/F07: Ø30, 8 X 7 FA/F10: Ø42, 12 X 8	FA/F12: Ø64, 18 X 11 FA/F14: Ø64, 18 X 11	FA/F12: Ø64, 18 X 11 FA/F14: Ø64, 18 X 11	FA/F12: Ø64, 18 X 11 FA/F14: Ø64, 18 X 11
Maximum square drive, mm (in.)	FA/F05: 19 sq (0.75 sq) FA/F07: 25 sq (1 sq) FA/F10: 35 sq (1.41 sq)	FA/F07: 25 sq (1 sq) FA/F10: 35 sq (1.41 sq)	FA/F12: 45 sq (1.75 sq) FA/F14: 45 sq (1.75 sq)	FA/F12: 45 sq (1.75 sq) FA/F14: 45 sq (1.75 sq)	FA/F12: 45 sq (1.75 sq) FA/F14: 45 sq (1.75 sq)
Maximum double 'D' stem, mm (in.)	FA/F05: Ø27 (1.06) FA/F07: Ø36 (1.44) FA/F10: Ø50 (2.00)	FA/F07: Ø36 (1.44) FA/F10: Ø50 (2.00)	FA/F12: Ø64 (2.50) FA/F14: Ø64 (2.50)	FA/F12: Ø64 (2.50) FA/F14: Ø64 (2.50)	FA/F12: Ø64 (2.50) FA/F14: Ø64 (2.50)

Handwheel data by model

Parameter	QXb-1	QXb-2	QXb-3	QXb-4	QXb-5
Gear ratio, handwheel	200	200	276	276	276
Handwheel efficiency	26%	26%	26%	26%	26%
Handwheel diameter, mm (in.)	76 (3)	76 (3)	190 (7.5)	190 (7.5)	190 (7.5)
Handwheel turns for 90°	50	50	70	70	70
Handwheel shaft hex drive, mm (in.)	16 (0.63)	16 (0.63)	16 (0.63)	16 (0.63)	16 (0.63)

Weights

Parameter	QXb-1	QXb-2	QXb-3	QXb-4	QXb-5
Weight, kg (lb)	21 (45)	21 (45)	36.3 (80)	36.3 (80)	36.3 (80)

MXb LB linear drive actuators

A linear base (LB) can be added to MXb actuators to meet the demands of the choke and control valve markets. Two sizes, LB1 and LB2, are available to handle thrust up to 109 kN (25,000 lb).

Linear base advantages

The easily assembled mechanical base converts actuator torque to linear thrust. The standard A1 base is used to accept the valve thrust component, and both the LB and A1 bases are available with ISO flanges.

LB1 and LB2 bases can be ordered with the optional "EN" base for stem protection to EN 15714, Electric Actuators for Industrial Valves requirements. They are also ATEX 94/9/EC compliant.

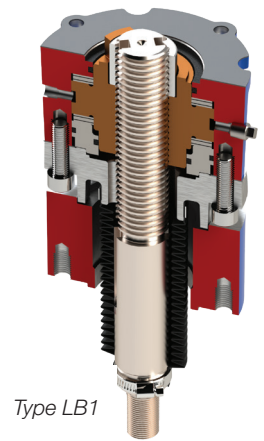

Type LB1

MXb units with linear base (LB1)

FA/F10 mounting base and a maximum stroke of 121 mm (4.77 in.)

Actuator model	Seating/unseating thrust		Modulating thrust		50 Hz linear speed		60 Hz linear speed	
	kN	lb	kN	lb	mm/s	in./min	mm/s	in./s
MXb-05	16	3,561	6	1,424	10.62	25.05	12.80	30.18
MXb-05	18	4,080	3	653	2.49	5.87	3.00	7.07
MXb-05	18	4,080	3	653	3.57	8.42	4.30	10.14
MXb-05	18	4,080	7	1,632	5.56	13.11	6.70	15.80
MXb-05	18	4,080	7	1,632	7.22	17.03	8.70	20.51
MXb-05	19	4,351	8	1,740	4.23	9.98	5.11	12.03
MXb-05	22	4,986	4	798	1.00	2.35	1.20	2.83
MXb-05	22	4,986	4	798	1.41	3.33	1.70	4.01
MXb-05	22	4,986	9	1,994	2.24	5.28	2.70	6.37
MXb-05	22	4,986	9	1,994	2.91	6.85	3.50	8.25
MXb-10	35	7,938	14	3,175	10.62	25.05	12.80	30.18
MXb-10	41	9,273	7	1,484	2.49	5.87	3.00	7.07
MXb-10	41	9,273	7	1,484	3.57	8.42	4.30	10.14
MXb-10	41	9,273	16	3,709	5.56	13.11	6.70	15.80
MXb-10	41	9,273	16	3,709	7.22	17.03	8.70	20.51
MXb-10	43	9,700	17	3,880	4.23	9.98	5.11	12.03
MXb-10	50	11,332	8	1,813	1.00	2.35	1.20	2.83
MXb-10	50	11,332	8	1,813	1.41	3.33	1.70	4.01
MXb-10	50	11,332	20	4,533	2.24	5.28	2.70	6.37
MXb-10	50	11,332	20	4,533	2.91	6.85	3.50	8.25

MXb units with linear base (LB2)

FA/F14 mounting base and a maximum stroke of 121 mm (4.77 in.)

Actuator model	Seating/unseating thrust		Modulating thrust		50 Hz linear speed		60 Hz linear speed	
	kN	lb	kN	lb	mm/s	in./min	mm/s	in./s
MXb-20	40	8,900	16	3,560	8.55	20.16	10.30	24.29
MXb-20	44	9,883	18	3,953	3.24	7.63	3.90	9.20
MXb-20	50	11,250	8	1,800	2.91	6.85	3.50	8.25
MXb-20	50	11,250	20	4,500	4.40	10.37	5.30	12.50
MXb-20	50	11,250	20	4,500	5.73	13.50	6.90	16.27
MXb-20	56	12,493	9	1,999	1.08	2.54	1.30	3.07
MXb-20	56	12,493	22	4,997	1.66	3.91	2.00	4.72
MXb-20	56	12,493	22	4,997	2.16	5.09	2.60	6.13
MXb-40	77	17,250	31	6,900	8.55	20.16	10.30	24.29
MXb-40	85	19,156	34	7,662	3.24	7.63	3.90	9.20
MXb-40	98	22,000	16	3,520	2.91	6.85	3.50	8.25
MXb-40	98	22,000	39	8,800	4.40	10.37	5.30	12.50
MXb-40	98	22,000	39	8,800	5.73	13.50	6.90	16.27
MXb-40	109	24,431	17	3,909	1.08	2.54	1.30	3.07
MXb-40	109	24,431	43	9,772	1.66	3.91	2.00	4.72
MXb-40	109	24,431	43	9,772	2.16	5.09	2.60	6.13

Charts shown with LB thrusts and actuator torques calculated at a modulating rate of 100 starts per hour.

Contact factory for other modulating rates up to 1,800 starts per hour.

QXMb multi-turn or QXMb LB linear actuators

The industry-leading features of the QXb quarter-turn actuator are available in a limited multi-turn version, the QXMb smart electric actuator. It's designed for short-stroke, light-torque, rising stem valve applications such as choke or control valves.

The QXMb absolute encoder employs system-on-chip technology using a contactless magnet that excites Hall effect devices. This provides redundant, 12-bit resolution over 20 turns, resulting in a resolution of 2.2°.

A linear base (LB) also can be added to QXMb actuators to convert actuator torque to linear thrust. The QXMb actuator fitted with the A1 and LB1 bases will meet the majority of requirements for smaller choke and control valves.

Technical specifications

The QXMb actuator is available for up to 20 turns with increased speed ranges from 2 to 24 rpm. When combined with faster speeds, torque ranges are consistent with the speeds required for limited linear travel. Additional features and options include:

- Available with an **“H” high-torque motor** or **“L” low-torque motor** to offer a broad torque and speed range from 24 Nm (18 ft-lb) to an industry-leading 337 Nm (250 ft-lb)
- The motors have **H class insulation** as standard and are rated to IEC 34 as S2-15min at 40%.
- An **A1 base** can be attached to the QXMb actuator for travel up to 70 mm (2.76 in.).

Actuator model	Speed, rpm	Torque		Time to close, s	
		Nm	(ft-lb)	6.5 turns	20 turns
QXMb-1	3	136	100	130	400
QXMb-2	2	339	250	195	600
QXMb-1/L	6	61	45	65	200
QXMb-1/L	12	65	48	33	100
QXMb-1/L	18	45	33	22	67
QXMb-1/L	24	30	22	16	50
QXMb-1/H	6	122	90	65	200
QXMb-1/H	12	106	78	33	100
QXMb-1/H	18	75	55	22	67
QXMb-1/H	24	52	38	16	50

QXMb units with linear base (LB1)

FA/F10 mounting base

Actuator model	Speed, rpm	Stem/pitch, mm	Thrust (on-off/modulating)		Rate of travel (50/60 Hz)		Max. travel	
			kN	lb	mm/s	in./min	mm	in.
QXMb-1	3	32x4	40	9,065	0.2	0.47	26	1.02
QXMb-1	3	32x10	33	7,418	0.5	1.18	65	2.6
QXMb-1/L	6	32x4	14	3,173	0.4	0.94	26	1.02
QXMb-1/L	6	32x10	12	2,596	1	2.36	65	2.6
QXMb-1/L	12	32x4	12	2,720	0.8	1.89	76	3
QXMb-1/L	12	32x10	10	2,226	2	4.72	76	3
QXMb-1/L	18	32x4	8	1,813	1.2	2.83	76	3
QXMb-1/L	18	32x10	7	1,484	3	7.07	76	3
QXMb-1/L	24	32x4	3	725	1.6	3.77	76	3
QXMb-1/L	24	32x10	3	593	4	9.43	76	3
QXMb-1/H	6	32x4	14	3,173	0.4	0.94	26	1.02
QXMb-1/H	6	32x10	12	2,596	1	2.36	65	2.6
QXMb-1/H	12	32x4	12	2,720	0.8	1.89	76	3
QXMb-1/H	12	32x10	10	2,226	2	4.72	76	3
QXMb-1/H	18	32x4	8	1,813	1.2	2.83	76	3
QXMb-1/H	18	32x10	7	1,484	3	7.07	76	3
QXMb-1/H	24	32x4	3	725	1.6	3.77	76	3
QXMb-1/H	24	32x10	3	593	4	9.43	76	3

Couplings

MXb

Thrust drive couplings

- **Type A1** – Alloy bronze (thrust)
- **Type A1E** – Extended bronze nut
- **Type LB linear bases** – Type LB1 for control and choke valve applications (see pages 24 and 25 for more information)

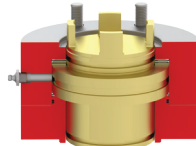

Type A1

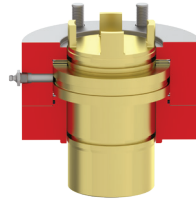

Type A1E

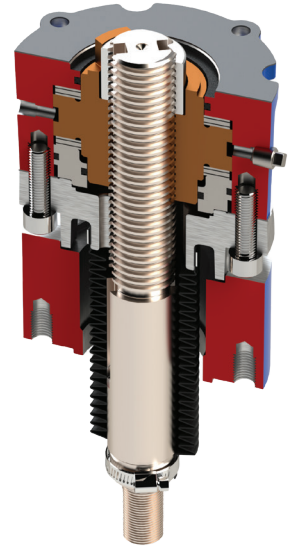

Type LB1

Torque-only drive couplings

- **Type B4** – Standard steel bushing
- **Type B4E** – Extended steel bushing
- **Type B1** – Large fixed-bore keyway steel bushing (ISO 5210)
- **Type BL** – Splined steel bushing for rising rotating stem valves

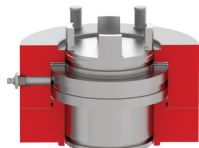

Type B1

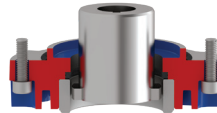

Type B4

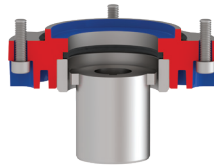

Type B4E

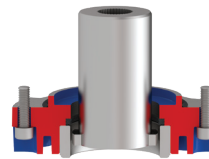

Type BL

QXb

Thrust drive couplings

- Type A1** – Alloy bronze (thrust)
- Type A1E** – Extended bronze nut

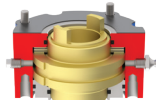

Type A1

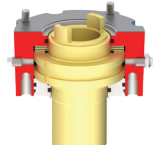

Type A1E

Torque-only drive couplings

- Type B4** – Standard steel bushing
- Type B4E** – Extended steel bushing

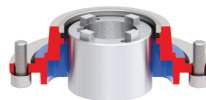

Type B4

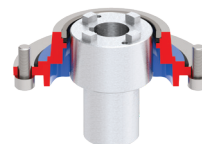

Type B4E

Technical details

Components and controls

MXb and QXb actuators are designed for the operation of on-off and modulating valves. They may include the following components and controls:

- Absolute encoder
- Electronic control
- Electronic torque sensor
- Handwheel for manual operation
- LCD screen with 240x160 pixel resolution
- Local control switches
- Protection and monitoring package
- Reversing motor contactor
- Three-phase electric motor (MXb)
 - Brushless DC motor (QXb) Valve interface bushing
- Worm gear reduction

Everything is contained in an enclosure sealed to NEMA 4, 4X, 6 and IP68. XP enclosures can also be provided when required.

All MXb and QXb actuators comply with applicable European Directives and exhibit the CE and UK CA marks.

Power transmission and lubrication

All mechanical gearing components are bearing supported, and final drive (output) consists of a hardened alloy steel worm and alloy worm gear.

All gears are immersed in an oil bath lubricated with a synthetic oil designed specifically for extreme pressure and worm gear transmission service. Special lubricants are available for operation in temperatures below -30°C (-22°F).

Lubrication and temperature range	Synthetic brand
Standard lubrication: -30°C to 70°C (-22°F to 158°F)	Mobile SHC 323
Optional food-grade lubrication: -30°C to 70°C (-22°F to 158°F)	Dow Molykote

Motors

MXb – three-phase ACV: The MXb actuator’s motor is a three-phase squirrel cage design that is specifically made for the MXb actuator. It complies with EN15714-2 (ISO 22153) and IEC 34, S2-15min (as standard) duty cycle at a rate of 60 starts per hour at a rate up to 600 starts per hour at 30% of rated torque.

QXb – brushless DC motor: The QXb motor is unique to quarter-turn electronic valve actuators. It is a brushless DC motor specifically designed for QX series actuators and complies with IEC 34, S2-15min duty cycle at 40% of rated torque.

Both MXb and QXb motors are true bolt-on designs with a quick-disconnect plug that can be changed rapidly without sacrificing motor leads. They are equipped with a solid-state motor thermistor to prevent damage due to temperature overloads.

On-off modulating options
<ul style="list-style-type: none"> • All MXb units: Standard insulation class is F to IEC 34. All QXb units: Standard insulation class is H to IEC 34. S4-50% for stated operating times is 100 to 600 starts per hour. • For MXb units with SSMR and all QXb units: 600 to 1,200 starts per hour; IEC 34, S4-50% is 1,200 starts per hour.

Motor voltages

The MXb and QXb actuator motors permit a global range of voltages. They can be built to operate at any one of the following voltages:

Product	Phase/frequency	Application voltage
MXb	Three-phase, 60 Hz	208, 220, 230, 240, 380, 440, 460, 480, 575
	Three-phase, 50 Hz	380, 400, 415, 440
QXb	VDC	24 to 48
	Single-phase, 60 Hz	110, 115, 120, 240
	Single-phase, 50 Hz	220 to 250
	Three-phase, 60 Hz	208, 220, 230, 240, 380, 440, 460, 480, 550, 575, 600
	Three-phase, 50 Hz	220, 380, 400, 415, 440, 525

Technical details (continued)

Electronic control modules

Non-intrusive

MXb and QXb actuators are non-intrusive, which means that all set-up and configuration is possible without removing any covers and without the use of any special tools.

Set-up is performed in clear text languages; no icons are used. It's also performed through its 2D menu structure, easy-to-use navigation via the use of the rotary menu knob for up and down movements, and the black open/close switch for selection, forward or backward movements through the menus.

Double-sealed terminal compartment and terminal block

All customer connections are located in a terminal chamber that is separately sealed from all other actuator components, via O-ring double sealing. Site wiring doesn't expose actuator components to the environment. The internal sealing within the terminal chamber is compliant with NEMA 4, 6 and IP68 to a minimum of 96 hours at 15 m.

Connections can be installed without power and still provide anti-condensation properties instead of relying on a heater to prevent condensation, which requires power, even during early installation.

The terminal block includes screw-type terminals: three for power and 54 for control. Customer connections are made via conduits located in the terminal housing.

Model	Three standard conduit openings (NPT threads standard)
MXb	(2) – 1.25 in. NPT (standard) (1) – 1.5 in. NPT (standard) (1) – 1.0 in. NPT (optional)
QXb	(3) – 1.00 in. NPT (standard) (1) – 1.25 in. NPT (optional)

Note: Certified metric conduit adapters are available upon request.

Controls

MXb contactor and QXb solid-state controls include power and logic circuit boards and a motor controller that performs as the motor reverser, all mounted to a steel plate and attached in the control compartment with captive screws.

All internal wiring is flame-resistant, rated to 105°C (221°F), and UL/CSA listed.

The controls are housed in the actuator control panel (ACP) cover, and the logic module uses solid-state Hall effect devices for local communication and configuration.

A 240x160 pixel resolution LCD is included to display valve position from 0 to 100% Open along with the current actuator status.

- Red and green reversible LEDs are included to signal 'Opened' and 'Closed'.
- A yellow LED indicates "Valve Moving".
- A blue LED shines when the Bluetooth feature is recognized by an external Bluetooth LE-enabled device.
- A white LED turns on for "Overtorque Fault" or "Torque Seated".

A lockable "Local-Stop-Remote" switch and an "Open-Close" switch are included for local valve actuator control.

Using the rotary knobs and LCD screen, MXb and QXb actuators are configurable in 11 languages: Bahasa Indonesia, English, French, German, Italian, Katakana, Mandarin, Portuguese, Russian, Spanish and Turkish.



Status (S) contacts for remote indication

Four latching status contacts rated 250 VAC, 5A and 30 VDC, 5A are provided for remote indication of valve position, configured as 1-N/O and 1-N/C for both the open and closed positions.

The contacts may be configured in any of the selections depicted in the “Actuator Status Message” column.

“S” contact AC	“S” contact DC
5 Amps @ 250 VAC	5A @ 30 VDC

Note: The contacts are rated 5.0 A at 250 VAC, 30 VDC. The total combined current through all four status contacts must not exceed 8 A.



Actuator status message	Function
“Closed”	Valve closed “(0% OPEN)”
“Opened”	Valve open “(100% OPEN)”
“Closing”	Valve closing
“Opening”	Valve opening
“Stopped”	Valve stopped in mid-travel
“Valve Moving”	Either direction
“Local Selected”	Red selector knob in “LOCAL”
“Motor Overtemp”	Thermistor range exceeded
“Overtorque”	Torque exceeded in mid-travel
“Manual Override”	Actuator moved by handwheel
“Valve Jammed”	Valve can’t move
“Close Torque SW”	Torque switch trip at “CLOSED”
“Open Torque SW”	Torque switch trip at “OPEN”
“Local Stop/Off”	Red selector knob at “STOP”
“Lost Phase”	One or more of the incoming supply lost
“ESD Signal”	Signal active
“Close Inhibit”	Close inhibit signal active
“Open Inhibit”	Open inhibit signal active
“Analog IP Lost”	4–20 mA not present
“Remote Selected”	Red selector in “REMOTE”
“Hardware Failure”	Indication
“Network Controlled”	Permits relay control via DDC, FF, or other network driver
“Function”	LimiGuard circuit protection activated
“Mid-Travel”	Valve position, 1 to 99% open
“CSE Control”	CSE station in LOCAL or STOP and controls actuator
“PS Active”	Partial stroke test in operation
“PS Passed”	PS test complete and successful
“PS Failed Target”	PS test did not achieve target value
“PS Failed Returns”	PS test did not return to start position
“PS”	Partial stroke, active if “PS” configured
“Run Load Alarm”	Single phase only
“DPTS Open”	Open torque switch trip (open torque seat or open overtorque)
“DPTS Close”	Close torque switch trip (close torque seat or close overtorque)



Technical details (continued)

Monitor relay for remote indication

A standard monitor relay trips when the MXb or QXb actuator is not available for remote operation. Both N/O and N/C contacts are included, rated 250 VAC, 5 A and 30 VDC, 5 A.

The monitor relay is hard-set for lost phase, valve jammed and motor overheating, but can be additionally configured for local knob movement, over-torque, inhibits active or ESD active.

A yellow LED blinks when the monitor relay is active. An operator can disable the monitor relay.

Monitor relay AC	Monitor relay DC
5A @ 250 VAC (resistive)	5A @ 30 VDC (resistive)

Remote control

Discrete remote control (user supplied) may be configured as two, three or four wires for Open-Stop-Close control.

Remote control functions may be powered by external 24 VDC, 110 VAC, or the actuator's internal 24 VDC supply or optional 110 VAC supply. The internal supplies are protected against over-current and short-circuit faults and utilize optical isolation to minimize electromagnetic interference.

Discrete control provides isolated commons for up to three selections.

Signal threshold for voltage values	Maximum load
5.0 VAC/VDC maximum 'OFF'	24 VDC + 2 mA
19.2 VAC/VDC minimum 'ON'	110 VAC + 10 mA

Speed control

MXb and QXb actuators permit operational speeds in either Open and Closed directions to be set independently. They also have an industry-leading span for the optional two-speed timer.

MXb speed control

Two-speed timer span "on" pulse	Two-speed timer span "off" pulse
1.0 to 20 s (0.5 s increments)	1.0 to 200 s (1.0 s increments)

QXb speed control

Model	Speed (open to close)		Two-speed timer span	
	min.	max.	"On" pulse	"Off" pulse
QXb-1	5 s	20 s	1.0 to 20 s (0.5 s increments)	1.0 to 200 s (1.0 s increments)
QXb-2	8 s	30 s	1.0 to 20 s (0.5 s increments)	1.0 to 200 s (1.0 s increments)
QXb-3	15 s	60 s	1.0 to 20 s (0.5 s increments)	1.0 to 200 s (1.0 s increments)
QXb-4	30 s	120 s	1.0 to 20 s (0.5 s increments)	1.0 to 200 s (1.0 s increments)
QXb-5	60 s	120 s	1.0 to 20 s (0.5 s increments)	1.0 to 200 s (1.0 s increments)

Software

Limitorque LimiGard

A dedicated circuit to prevent undesired valve operation in the event of an internal circuit fault or erratic command signal is included as standard on each MXb and QXb actuator.

- A single-point failure will not result in erratic actuator movement nor will an open or short circuit in the internal circuit board logic energize the motor controller.
- The command inputs are optically coupled and require a valid signal pulse width from at least 250 to 350 ms to either turn on or off.
- In the event of an internal circuit fault, an alarm is signaled by tripping the monitor relay and through LCD indication.
- The control module also includes an auto reversal delay to inhibit high-current surges caused by rapid motor reversals.

Phase detection and correction (three-phase)

A phase correction circuit is included to correct motor rotation faults caused by incorrect site wiring or phase switching in the event of a power outage.

- The phase correction circuit also detects the loss of a phase and disables operation to prevent motor damage.
- The monitor relay will trip and an error message is displayed on the LCD screen when loss of phase occurs.

Multi-mode remote control

The MXb and QXb actuators are the first smart actuators that can be configured for multi-mode remote control, which permits discrete wiring for:

- Two, three or four wires, or network (Fieldbuses) for Open-Stop-Close control
- Response to the last signal received

The actuators can also distinguish analog control for modulating applications.

Emergency shutdown (ESD)

The emergency shutdown (ESD) has up to three configurable inputs for ESD. The ESD signal(s) can be selected to override any existing signal in order to actuate the valve to its configured emergency position. Provision for an isolated common is standard.

Inhibits

The MXb and QXb actuators have standard provisions for inhibit movement and also contain up to three configurable inputs. Provision for an isolated common is also standard.

Valve and actuator position sensing

Valve position is sensed by an 18-bit, optical, absolute position encoder with redundant position-sensing circuits designed for BIST.

The BIST feature discerns which failures will signal a warning only and which require a warning plus safe shutdown of the MXb or QXb actuator.

Open and closed positions are stored in permanent, non-volatile memory. The encoder measures valve position at all times, including both motor and handwheel operation, with or without power present, and without the use of a battery.

- The absolute encoder is capable of resolving $\pm 7^\circ$ of output shaft position over 10,000 output drive rotations.
- This design permits continuous monitoring of valve position during motor and handwheel operation.
- The encoder is 100% repeatable and requires no backup power source for operation.
- Output is used to control the open and closed valve positions and measure and report valve position, as well as provide local and remote position feedback.
- Positioning accuracy is better than 99% for valves requiring 50 or more turns.



Technical details (continued)

Exterior corrosion protection

As standard, MXb and QXb actuators are coated with a high-durability polyester powder coat designed for exterior exposure, providing excellent gloss retention and resistance to color change. Optional coatings that are suitable for exposure to an ASTM B117 salt spray test for 2,000 hours are available.

Manual operation

A metal handwheel and declutch lever provide for manual operation. Changing from motor to manual operation is accomplished by engaging the declutch lever. Energizing the motor returns the MXb or QXb actuator to motor operation.

- The lever can be padlocked in either motor or manual operation.
- Optional configurations for handwheels are available.



Factory testing

Every MXb or QXb actuator is factory tested to verify rated:

- Control power supply
- Customer inputs and outputs
- Direction of rotation
- Handwheel operation
- LCD and LED operations
- Local control
- Microprocessor checks
- Motor current and thermistor
- Output speed and torque
- Position-sensor checks
- Valve jammed function

Design life and endurance testing

- AWWA C542-16 – “Electric Motor Actuators for Valves and Slide Gates” – 5,000 cycles with confirmation of specified torque and position accuracy.
- Design life – One million drive sleeve turns under normal operating conditions and approved ambient working environments.
- Endurance – 50 million collective drive sleeve turns of endurance testing were performed for proof of design.

Optional features

Analog position transmitter

A non-contacting, internally powered, electrically isolated position transmitter can be included with the MXb or QXb actuator to provide a 4-20 mA or 0 to 10 VDC signal that is proportional to the valve's position.

Voltages or currents for APT/ATT	Maximum/minimum external load — APT/ATT
4-20 mA	470 ohms—99.9% accuracy 750 ohms for 99% accuracy
0 to 10 VDC	1,000 ohms minimum—99.9% accuracy 2,700 ohms minimum—99% accuracy

Analog torque transmitter

A non-contacting, internally powered, electrically isolated torque transmitter can be included to provide a 4-20 mA or 0 to 10 VDC signal that is proportional to rated output torque.

Modutronic option

A controller that alters valve position in proportion to a 4-20 mA analog command signal can be ordered with the MXb or QXb actuator.

- Positioning is accomplished by comparing the command signal to a non-contacting internal position feedback.
- An automatic pulsing feature to prevent overshoot at the setpoint is included.
- Proportional bands, deadband, signal polarity, motion inhibits time and fail are adjustable using the local control mode of configuration.
- Deadband is adjustable to +/- 0.5% full span.

Voltages or currents for modulation	Input impedance/capacitance
4-20 mA	470 ohms—99.9% accuracy 750 ohms for 99% accuracy
0 to 10 VDC	1,000 ohms minimum—99.9% accuracy 2,700 ohms minimum—99% accuracy

Relays for status and alarms

Up to four additional latching output contacts rated 250 VAC/30 VDC, 5 A and configurable to represent any actuator status in either N/O or N/C state are available. The contacts are rated 5.0 A at 250 VAC, 30 VDC. The total combined current through all four status contacts must not exceed 8 A.

"R" contact and AC ratings	"R" contact and DC ratings
5.0 Amps @ 250 VAC	5A @ 30 VDC (resistive)

Global certifications

Weather-proof, submersion and corrosion ratings

Model	Weather-proof/submersion		Optional corrosion resistance	
	Enclosure rating	Rating	Certification	Rating
MXb	IEC 60529 Protection Code IP66, IP68	IP68: 15 m for 96 hours	C5-m optional	2,000 hours to ASTM B117-16
	USA and Canada, NEMA 3, 4, 6	NEMA 6: 20 ft for 24 hours		
QXb	IEC 60529 Protection Code IP66, IP68	IP68: 15 m for 96 hours	C5-m optional	2,000 hours to ASTM B117-16
	USA and Canada, NEMA 3, 4, 6	NEMA 6: 20 ft for 24 hours		

Standard hazardous global certifications

Model	Certification mark	XP classification	Enclosure	Temperature rating	
				Standard	Low ambient
MXb	FM (U.S.)	Class I Division 1 Groups C & D T4 Class II Division 1 Groups F & G T4	Type 3, 4, 4X, 6 IP66 IP68	$-30^{\circ}\text{C} \leq T_{\text{AMB}} \leq 65^{\circ}\text{C}$	$-50^{\circ}\text{C} \leq T_{\text{AMB}} \leq 40^{\circ}\text{C}$
		Class I Division 1 Groups B, C & D T4 Class II Division 1 Groups E, F & G T4			N/A
	IECEX	Ex db IIB T4 Ex db IIB or IIC T4 Ex db eb IIB or IIC T4	IP66 IP68	$-20^{\circ}\text{C} \leq T_{\text{AMB}} \leq 65^{\circ}\text{C}$	$-60^{\circ}\text{C} \leq T_{\text{AMB}} \leq 40^{\circ}\text{C}$
					N/A
					N/A
	ATEX	II 2 G Ex db h IIB T4 Gb II 2 G Ex db h IIB or IIC T6 Gb II 2 G Ex db eb h IIB or IIC T6 Gb	IP66 IP68	$-20^{\circ}\text{C} \leq T_{\text{AMB}} \leq 65^{\circ}\text{C}$	$-60^{\circ}\text{C} \leq T_{\text{AMB}} \leq 40^{\circ}\text{C}$
N/A					
N/A					
QXb	FM (U.S.)	Class I Division 1 Groups C & D T6 Class II Division 1 Groups F & G T6	Type 3, 4, 4X IP66 IP68	$-30^{\circ}\text{C} \leq T_{\text{AMB}} \leq 70^{\circ}\text{C}$	$-50^{\circ}\text{C} \leq T_{\text{AMB}} \leq 40^{\circ}\text{C}$
		Class I Division 1 Groups B, C & D T6 Class II Division 1 Groups E, F & G T6			N/A
	FM (Canada)	Class I Division 1 Groups C & D T6 Class II Division 1 Groups F & G T6	Type 3, 4, 4X, 6 IP66 IP68	$-30^{\circ}\text{C} \leq T_{\text{AMB}} \leq 70^{\circ}\text{C}$	$-50^{\circ}\text{C} \leq T_{\text{AMB}} \leq 40^{\circ}\text{C}$
		Class I Division 1 Groups B, C & D T6 Class II Division 1 Groups E, F & G T6			N/A
	IECEX	Ex db IIB T6 Ex db IIB or IIC T6 Ex db eb IIB or IIC T6	IP66 IP68	$-20^{\circ}\text{C} \leq T_{\text{AMB}} \leq 70^{\circ}\text{C}$	$-55^{\circ}\text{C} \leq T_{\text{AMB}} \leq 40^{\circ}\text{C}$
					N/A
					N/A
	ATEX	II 2 G Ex db h IIB T6 Gb II 2 G Ex db h IIB or IIC T6 Gb II 2 G Ex db eb h IIB or IIC T6 Gb	IP66 IP68	$-20^{\circ}\text{C} \leq T_{\text{AMB}} \leq 70^{\circ}\text{C}$	$-55^{\circ}\text{C} \leq T_{\text{AMB}} \leq 40^{\circ}\text{C}$
					N/A
					N/A

Note: Consult factory for additional global certifications.

European directives

All MXb and QXb actuator designs have been tested to comply with pertinent EU Directives and are shipped with the Declaration of Conformity listed in the Regulatory Section of VAIOM000071 and AIOM000517.

Vibration and seismic ratings

MXb/QXb actuators comply with EN 60068-2, MIL-STD-167-1A, and IEEE standard 344-2013.

	Vibration levels (Actuator functions after event)	Seismic levels (Actuator functions after event)
MXb	5 to 100 Hz sine sweeps, 0.75g 3 axes; 100 to 500 Hz, 1g 3 axes	sine sweeps, 3 axes, (Hz/G): 1/0.5, 2-5/1
	25 Hz 2g, 40 to 200 Hz 3g, sine dwell, 3 axes	sine dwell, 3 axes, (Hz/G): 2/2, 2.5 to 35/3
QXb	5 to 500 Hz sine sweeps, 2g 3 axes	sine sweeps, 3 axes, (Hz/G): 1/0.4, 1 to 2/0.4 to 0.8, 2 to 5/0.8 to 2, 5 to 50/2
	25 Hz 2g, 40 to 200 Hz 3g, sine dwell, 3 axes	sine dwell, 3 axes, (Hz/G): 2/1.4, 2.5/2.3, 3.5/3.2, 4/4, 5-35/5
		sine beats (Hz/g): 3.5/4.7, 4/5.4, 5/6.4, 6.3/8.2, 8 to 35/10

Emissions and immunity standards

Three-phase/single-phase ACV or DCV actuators comply with all pertinent requirements of Class A service categories listed below.

Test	Port	EN 301 489-1 V2.2.0 (2017), EN 301 489-17 V3.1.1 (2016-11) and EN 61326-1:2013		
		Method	Level	
Radiated emissions	Enclosure (3 m [10 ft])	EN 55032: 2012, AC:2013 EN 55011:2015, A1:2016 EN 55011:2009, A1:2010 CFR47 Part 15	30 to 230 MHz	50 dB μ V/m (quasi-pk)
			230 MHz to 1 GHz	57 dB μ V/m (quasi-pk)
			1 to 3 GHz	56 dB μ V/m (average)
			3 to 6 GHz	60 dB μ V/m (average)
Conducted emissions	AC power	EN 55032:2015 EN 55011:2009, A1:2010 CFR47 Part 15	0.15 to 0.5 MHz	79 dB μ V (quasi-pk)
				66 dB μ V (average)
			0.5 to 30 MHz	73 dB μ V (quasi-pk)
				60 dB μ V (average)
Electrostatic discharge	Enclosure	EN 61000-4-2:2009	Contact: Direct	\pm 1 kV, \pm 2 kV, \pm 4 kV
	HCP/VCP		Air	\pm 2 kV, \pm 4 kV, \pm 8 kV
			Contact: Indirect	\pm 1 kV, \pm 2 kV, \pm 4 kV
Radiated RF susceptibility	Enclosure vertical and horizontal (window side only)	EN 61000-4-3:2006, A1:2008, A2:2010	80 MHz to 1.0 GHz	10 Vrms/m @ 80% AM, 1 kHz
			1.0 to 6.0 GHz	3 Vrms/m @ 80% AM, 1 kHz
Electrical fast transient/burst	AC power	EN 61000-4-4:2004, A1:2010	CDN injection	\pm 2 kV (5/50 ns @ 5 kHz)
	DC power, I/O		Clamp injection	\pm 1 kV (5/50 ns @ 5 kHz)
Voltage surge	AC power	EN 61000-4-5:2006	Differential mode	\pm 1 kV @ 1.2/50 μ s (line-line)
	DC power, I/O		Common mode	\pm 2 kV @ 1.2/50 μ s (line-ground)
			Common mode	\pm 1 kV @ 1.2/50 μ s (line-ground)
Conducted RF susceptibility	AC/DC power, I/O	EN 61000-4-6:2009	150 kHz to 80 MHz	3 Vrms @ 80% AM, 1 kHz (20 mA max)
Magnetic immunity	Enclosure	EN 61000-4-8:2008	Three mounting axes: X, Y, Z 60 s dwells and 60 s pulsed	30 A/m @ 50 Hz
				30 A/m @ 60 Hz
Voltage dips and interrupts	AC power	EN 61000-4-11:2004	3x dips @ 10 s interval 50 Hz	100% dip for 1 cycle
				100% dip for 0.5 cycle
				60% dip for 10 cycles (200 ms)
				30% dip for 25 cycles (500 ms)
				100% interrupt 250 cycles (5 s)



Flowserve Corporation
5215 North O'Connor Blvd.
Suite 2300
Irving, Texas 75039-5421 USA

Flowserve Corporation has established industry leadership in the design and manufacture of its products. When properly selected, this Flowserve product is designed to perform its intended function safely during its useful life. However, the purchaser or user of Flowserve products should be aware that Flowserve products might be used in numerous applications under a wide variety of industrial service conditions. Although Flowserve can provide general guidelines, it cannot provide specific data and warnings for all possible applications. The purchaser/user must therefore assume the ultimate responsibility for the proper sizing and selection, installation, operation, and maintenance of Flowserve products. The purchaser/user should read and understand the Installation Instructions included with the product, and train its employees and contractors in the safe use of Flowserve products in connection with the specific application.

While the information and specifications contained in this literature are believed to be accurate, they are supplied for informative purposes only and should not be considered certified or as a guarantee of satisfactory results by reliance thereon. Nothing contained herein is to be construed as a warranty or guarantee, express or implied, regarding any matter with respect to this product. Because Flowserve is continually improving and upgrading its product design, the specifications, dimensions and information contained herein are subject to change without notice. Should any question arise concerning these provisions, the purchaser/user should contact Flowserve Corporation at any one of its worldwide operations or offices.

©2023 Flowserve Corporation. All rights reserved. This document contains registered and unregistered trademarks of Flowserve Corporation. Other company, product, or service names may be trademarks or service marks of their respective companies.

AIBR000087-04 (EN/A4) June 2023